

LED PANEL  
MODEL NO: ERK3463

# ERKled

TEKNİK BİLGİLER	
ÇALIŞMA VOLTAJI	AC 220-240V
FREKANS	50-60Hz
GÜCÜ (WATT)	6W
ENERJİ TÜKETİMİ	6kWh/1000 SAAT
ENERJİ VERİMLİLİĞİ EEL	G
GÖVDE	ALUMİNYUM
SINIF	II
IŞIK AKISI (LÜMEN)	330lm
BEYAN AKIMI (mA)	56mA
RA	>Ra70
GÜÇ FAKTÖRÜ	(PF): $\geq 0.55$
IŞIK KAYNAĞI TÜRÜ	LED - NDLS
RENK SICAKLIĞI:	6500K - 3000K - 4000K
KONTROL ÜNİTESİ	DC40-60V ( $\pm 5\%$ )
IŞIK DAĞILIMI	Direkt, 120°
IŞIK VERME SÜRESİ	< 0.5sn
CRI	>80
CIVA DEĞERİ (hg)	0.0mg
ÖMÜR	20.000 SAAT
IP DERECEŚİ	IP20 (İÇ MEKAN)
KAMAŞMA ÖNLEYİCİ SİPERLİK	VAR
RENGİ AYARLANAMAZ	
DİM ÖZELLİĞİ YOKTUR. IŞIK AKISI KISILAMAZ	

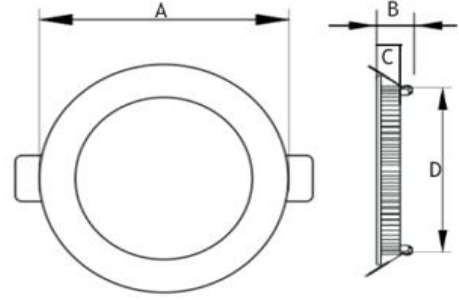

ÖLÇÜ (mm)

A	B	C	D
115	19	9	100



ÜRETİCİ

NTH ELEKTRİK VE GÜNEŞ ENERJİSİ SIS. İTH. İHR. SAN. TİC. LTD. ŞTİ  
MERİÇ MAH. KEMALPAŞA CAD. NO: 31 ÇAMDİBİ BORNOVA İZMİR

## Photometric Results

Lumens: 328.53 lm  
Efficiency: 49.7773 lm/W  
Central Intensity: 120.087cd  
Maximum Intensity: 121.394cd

Beam Angle(10%): Left: -78.9 Right:75.6

Angle of maximum intensity: C:0.0 G:5.0  
Half Peak Side Angle(50%): Left: -54.0 Right:53.0  
Light Out Rate(LOR): 100.00%  
Up Flux Rate: 0.0%  
Down Flux Rate: 100.0%

