

LED PANEL
MODEL NO: ERK3542

ERKled

TEKNİK BİLGİLER	
ÇALIŞMA VOLTAJI	AC 220-240V
FREKANS	50-60Hz
GÜCÜ (WATT)	12W
ENERJİ TÜKETİMİ	12kWh/1000 SAAT
ENERJİ VERİMLİLİĞİ EEL	G
GÖVDE	ALUMİNYUM
SINIF	II
IŞIK AKISI (LÜMEN)	750lm
BEYAN AKIMI (mA)	97mA
RA	>Ra70
GÜÇ FAKTÖRÜ	(PF): ≥ 0.55
IŞIK KAYNAĞI TÜRÜ	LED - NDLS
RENK SICAKLIĞI:	6500K - 3000K - 4000K
KONTROL ÜNİTESİ	DC24-45V ($\pm 5\%$)
IŞIK DAĞILIMI	Direkt, 120°
IŞIK VERME SÜRESİ	< 0.5sn
CRI	>80
CIVA DEĞERİ (hg)	0.0mg
ÖMÜR	20.000 SAAT
IP DERECEŚİ	IP20 (İÇ MEKAN)
KAMAŞMA ÖNLEYİCİ SİPERLİK	VAR
RENGİ AYARLANAMAZ	
DİM ÖZELLİĞİ YOKTUR. IŞIK AKISI KISILAMAZ	

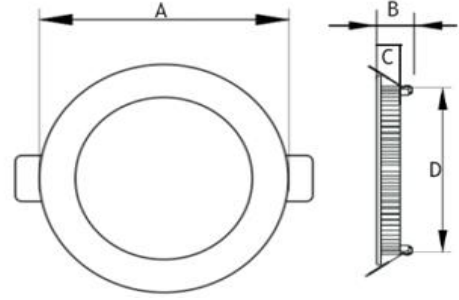

ÖLÇÜ (mm)

A	B	C	D
170	19	9	150



ÜRETİCİ

NTH ELEKTRİK VE GÜNEŞ ENERJİSİ SIS. İTH. İHR. SAN. TİC. LTD. ŞTİ
MERİÇ MAH. KEMALPAŞA CAD. NO: 31 ÇAMDİBİ BORNOVA İZMİR

Photometric Results

Lumens: 745.25 lm
Efficiency: 62.1042 lm/W
Central Intensity: 268.118cd
Maximum Intensity: 269.283cd

Beam Angle(10%): Left:-82.0 Right:77.5

Angle of maximum intensity: C:0.0 G:2.0
Half Peak Side Angle(50%): Left:-56.0 Right:53.7
Light Out Rate(LOR): 100.00%
Up Flux Rate: 0.0%
Down Flux Rate: 100.0%

